

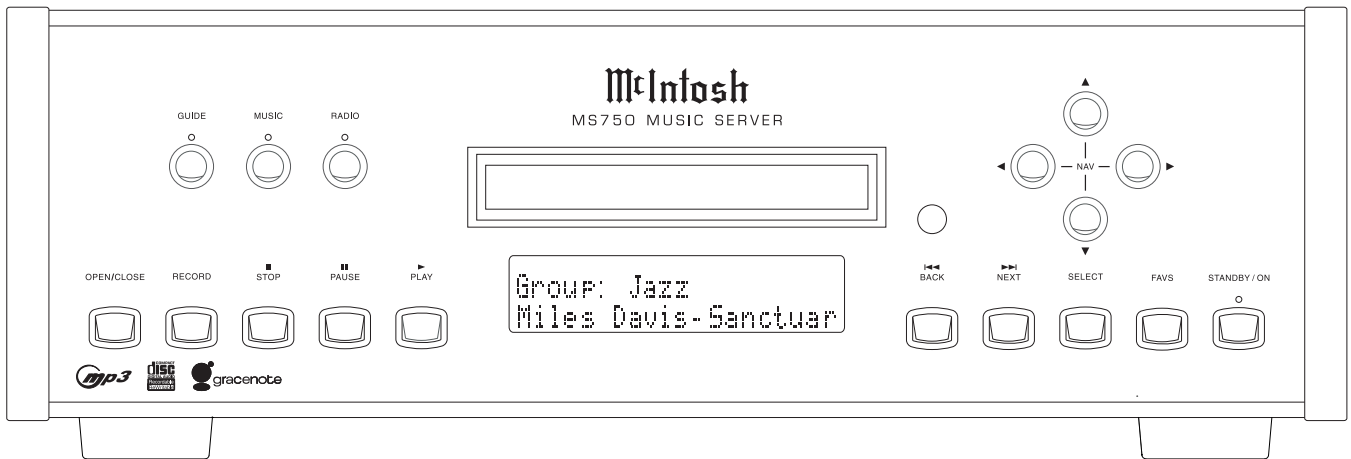

MS750

MUSIC SERVER

SERIAL NO. XU1001 And Above



CONTENTS

Performance Specifications.....	2	Block Diagram	4
Notes.....	2	Interconnection Diagram	5
Safety Information	2	Front Panel Schematic and PCB	7 - 10
Rear Panel	3	Parts List	11
Section Location.....	3	Repacking List	17

SERVICE MANUAL

Serial Number XU1001 And Above

PERFORMANCE SPECIFICATIONS

Audio Specifications

Output Level – 2.0Vrms
Output Impedance – 200 ohms
Audio Frequency Response – 2Hz to 22,000Hz \pm 1dB
Signal to Noise Ratio – 102dB (IHF A-Weighted)
Dynamic Range – 96dB
Harmonic Distortion – 0.01%
Channel Separation – 95dB (1,000Hz)

Video Specifications

Signal System – NTSC/PAL
Component Video Output Level
Y Output Level 1.0Vp-p (75 OHM)
 P_B/C_B Output Level 0.648Vp-p (75 OHM)
 P_R/C_R Output Level 0.7Vp-p (75 OHM)
S-Video Y Output Level – 1Vp-p (75 OHM)
S-Video C Output Level – 0.286Vp-p (75 OHM) (NTSC)
Composite Video Output Level – 1Vp-p (75 OHM)

General Specifications

Digital Output

Optical: -15dbm to -21dbm
Coaxial: 0.4V p-p to 0.6V p-p /75 ohm

Digital Signal Format – Sampling Frequency: 44.1kHz Power Requirements

100 Volts, 50/60Hz at 60 watts
110 Volts, 50/60Hz at 60 watts
120 Volts, 50/60Hz at 60 watts
220 Volts, 50/60Hz at 60 watts
230 Volts, 50/60Hz at 60 watts
240 Volts, 50/60Hz at 60 watts

Note Refer to the rear panel of the MS750 for the correct voltage.

Overall Dimensions

Width is 17-1/2 inches (44.45cm)
Height is 6 inches (15.24cm)
Depth is 15-7/8 inches (40.32cm)

Note When the Disc Tray is opened, the panel clearance required in front of mounting panel is 6-3/4 inches (17.2cm).

Weight

28.1 pounds (12.8Kg) net, 44.5 pounds (20.2Kg) in shipping carton

Shipping Carton Dimensions

Width is 26-1/2 inches (67.3cm)
Depth is 24-1/4 inches (62.2cm)
Height is 11-3/4 inches (29.9cm)

NOTES

1. Unless otherwise noted, all voltages indicated on the schematics are measured under the following conditions:
 - a. AC input at 120 volts, 50/60Hz.
 - b. All voltages are \pm 10% with respect to ground. A high impedance (10 megaohm) voltmeter must be used.
2. Unless otherwise specified:
 - a. Resistor values are in ohms.
 - b. Capacitor values are microfarads (μ F).
 - c. Inductor values are in microhenries (μ H)
3. On PC board drawings, Square pad indicates:
 - a. Polarized Capacitors - Positive
 - b. Diodes - Cathode
 - c. Others - Pin 1
4. **WARNING**
Parts marked with the symbol  have critical characteristics. Use only replacement parts recommended by the manufacturer.
5. Use McIntosh Remote Control Model HR063 with the MS750.

SAFETY INFORMATION

CAUTION: Invisible Laser Radiation when open. DO NOT stare into the beam or view directly with optical instruments. Use of controls or adjustments or performance of procedures other than those specified in the Owners Manual may result in Hazardous Radiation Exposure.

Servicing of laser mechanism is to be performed at the service facility at McIntosh Laboratory Inc.

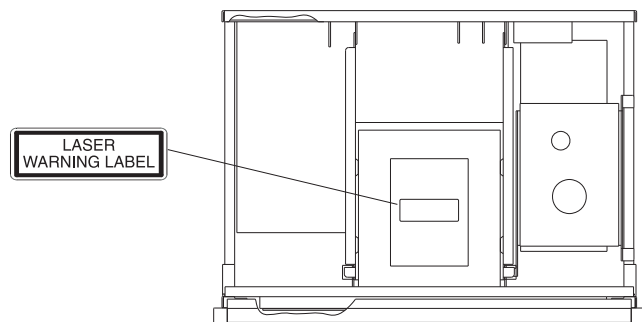

COMPLIES WITH DHHS RULES
21 CFR 1040.10 AND 1040.11

This product incorporates an embedded CLASS 3B Laser (IEC60825-1).

NOTES

1 INTERCONNECT

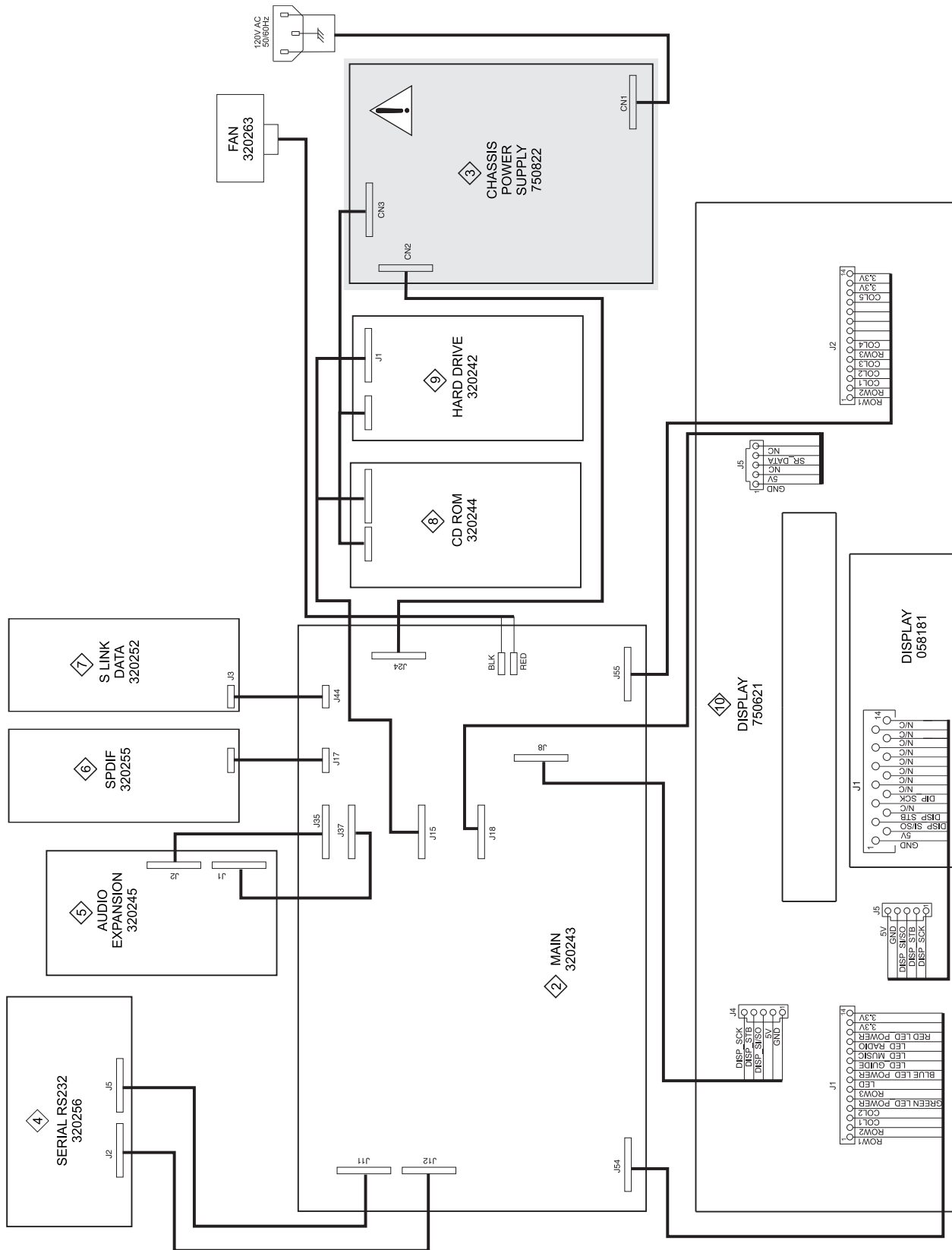

! WARNING Parts located in the shaded area have critical characteristics. Use only replacement parts recommended by the manufacturer.

NOTES

10 FRONT PANEL 750621 SCH

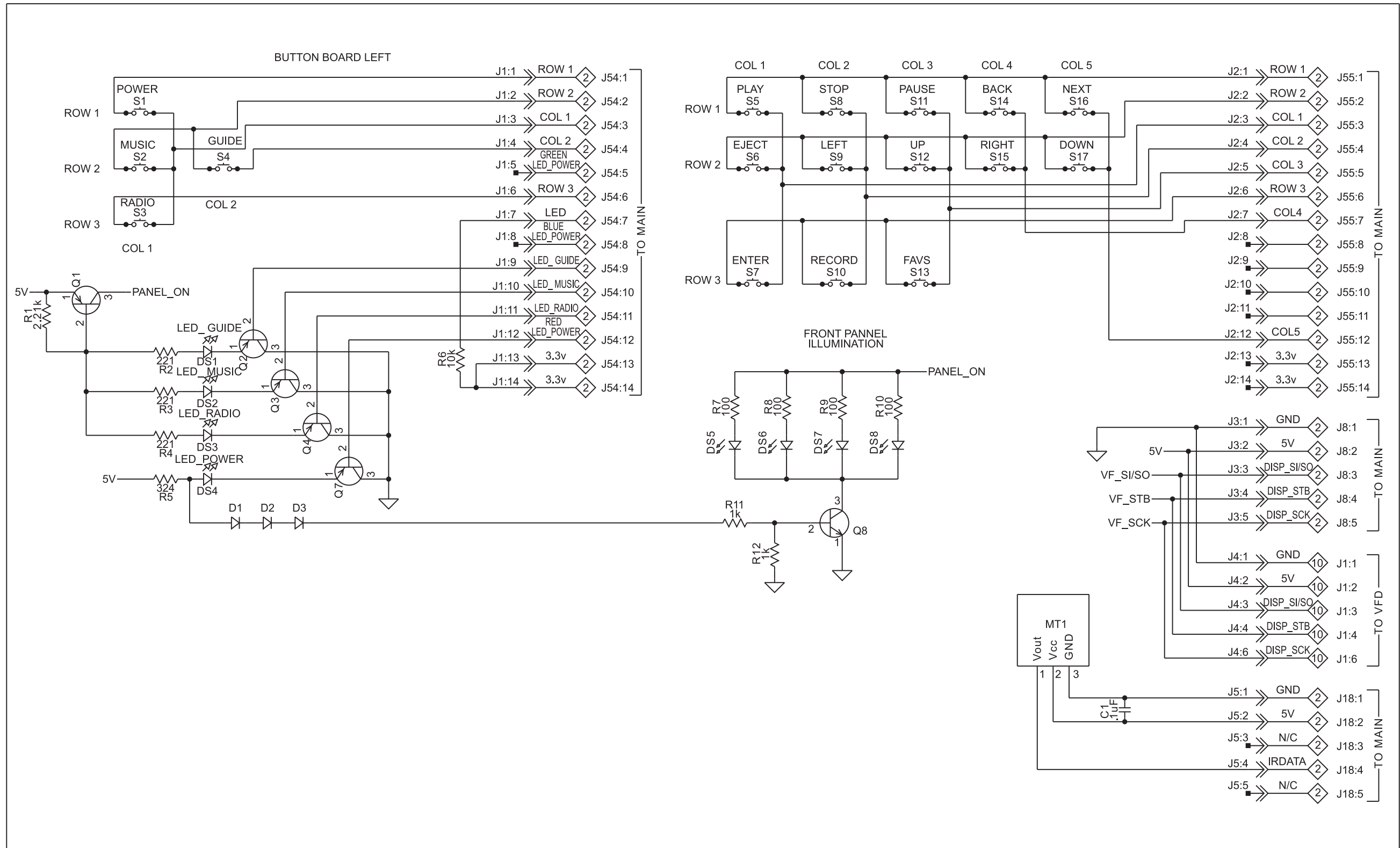

10 FRONT PANEL 750621 PCB

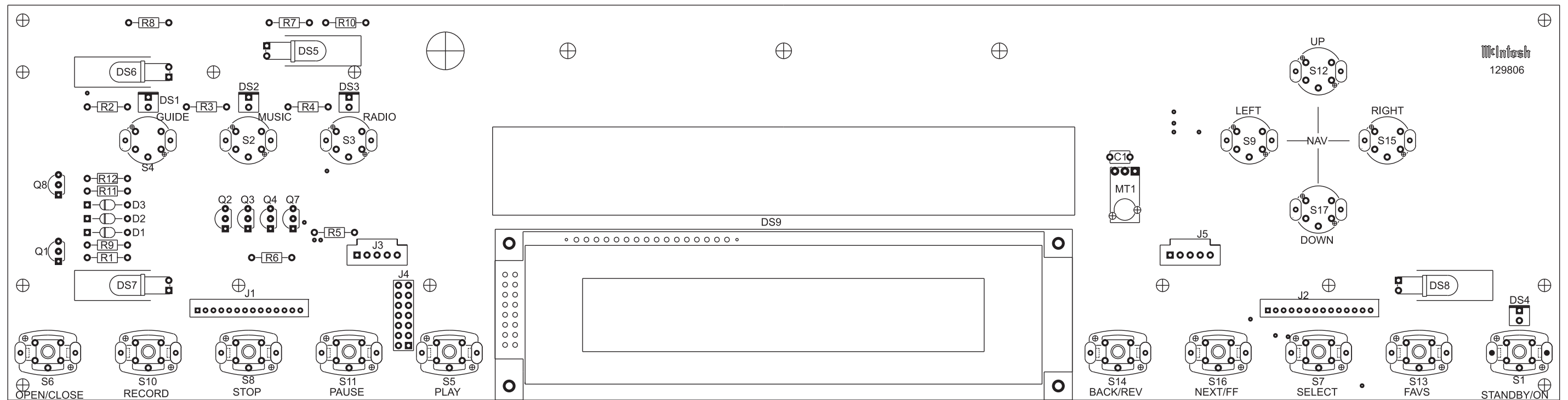

PARTS LIST

② 320243 MAIN PCB

③ 750822 CHASSIS POWER SUPPLY PCB

Ref. No.	Description	Part No.
	DIODE RECTIFIER 1N4007	070178
	FUSE T3 12AH250V PCB MOUNT	089144
	DECAL FUSE T3.15AH	166304
	POWER SUPPLY SWITCH MODE 75W	320247

④ 320256 SERIAL RS232 PCB

See Note

⑤ 320245 AUDIO EXPANSION PCB

See Note

⑥ 320255 SPDIF PCB

See Note

⑦ 320252 S LINK PCB

See Note

⑧ 320244 CD ROM PCB

See Note

⑨ 320242 HARD DRIVE

See Note

⑩ 750621 FRONT PANEL PCB

Ref. No.	Description	Part No.
C1	CAP MONO .1UF 50V 20% Z5U	061346
D1	DIODE SILICON	070174
D2	DIODE SILICON	070174
D3	DIODE SILICON	070174
DS1	LED SQUARE RED	058109
DS2	LED SQUARE RED	058109
DS3	LED SQUARE RED	058109
DS4	LED SQUARE RED	058109
DS5	LED GRN 5MM HI-INTENSITY	058165
(DS5)	SPACER LED	112108
DS6	LED GRN 5MM HI-INTENSITY	058165
(DS6)	SPACER LED	112108
DS7	LED GRN 5MM HI-INTENSITY	058165
(DS7)	SPACER LED	112108
DS8	LED GRN 5MM HI-INTENSITY	058165
(DS8)	SPACER LED	112108
DS9	DISPLAY VFD 2X20 CHAR 5X8 DOT	058181
DS9	TERMINAL STRIP 14 PIN .025 SQ	117647
	TUBING SHRINK 1/4ID BLK	077041
J1	CONN HEADER SHROUDED 1 X 14	117920
J2	CONN HEADER SHROUDED 1 X 14	117920
J3	CONN HEADER STRAIGHT 1 X 5	117874
J4	TERMINAL STRIP 14 PIN .025 SQ	117647
J5	CONN HEADER STRAIGHT 1 X 5	117874
MT1	SENSOR IR 38KHZ	121046

Ref. No. Description

Ref. No.	Description	Part No.
PCB1	PC BD DISPLAY	129806
Q1	TRANSISTOR PNP SILICON	132304
Q2	TRANSISTOR PNP SILICON	132304
Q3	TRANSISTOR PNP SILICON	132304
Q4	TRANSISTOR PNP SILICON	132304
Q7	TRANSISTOR PNP SILICON	132304
Q8	TRANSISTOR NPN SILICON	132317
R1	RES MF 2.21K 1% 1/4W	144584
R2	RES MF 221 OHM 1% 1/4W	144559
R3	RES MF 221 OHM 1% 1/4W	144559
R4	RES MF 221 OHM 1% 1/4W	144559
R5	RES MF 324 OHM 1% 1/4W	144597
R6	RES MF 10K 1% 1/4W	144504
R7	RES MF 100 OHM 1% 1/4W	144568
R8	RES MF 100 OHM 1% 1/4W	144568
R9	RES MF 100 OHM 1% 1/4W	144568
R10	RES MF 100 OHM 1% 1/4W	144568
R11	RES MF 1K 1% 1/4W	144513
R12	RES MF 1K 1% 1/4W	144513
S1	SWITCH TACT	150058
S2	SWITCH TACT	150058
S3	SWITCH TACT	150058
S4	SWITCH TACT	150058
S5	SWITCH TACT	150058
S6	SWITCH TACT	150058
S7	SWITCH TACT	150058
S8	SWITCH TACT	150058
S9	SWITCH TACT	150058
S10	SWITCH TACT	150058
S11	SWITCH TACT	150058
S12	SWITCH TACT	150058
S13	SWITCH TACT	150058
S14	SWITCH TACT	150058
S15	SWITCH TACT	150058
S16	SWITCH TACT	150058
S17	SWITCH TACT	150058
(DS1)	LED SPACER .220 LENGTH	163001
(DS2)	LED SPACER .220 LENGTH	163001
(DS3)	LED SPACER .220 LENGTH	163001
(DS4)	LED SPACER .220 LENGTH	163001
	C/A DISPLAY 14-1 X 2.0	171823
	SCR TS 2-32 X 1/4 PH PN TYPE B	401161

NOTE:

Modules not available as replacement parts. If defect is suspected in these modules, contact factory for service options.

NOTES

REPACKING INSTRUCTIONS

In the event it is necessary to repack the unit for shipment, the unit must be packed exactly as shown below.

IMPORTANT - The four plastic feet must be attached to the bottom of the unit so they will locate in the four holes of the bottom pad. Failure to do this will result in shipping damage.

If a shipping carton or any of the interior parts is needed, please call or write the Customer Service Department of McIntosh Laboratory. Order parts from the accompanying list by part number.

Use the original shipping carton and interior parts only if they are in good serviceable condition.

Qty.	Part No.	Description
1	033838	Shipping carton only
4	033837	Foam end cap
1	033836	Inside carton only
1	033725	Top pad
1	034301	Bottom pad
4	017937	Plastic foot
4	400159	#10-32 x 3/4" Machine screw
4	404080	#10 x 7/16" Flat washer

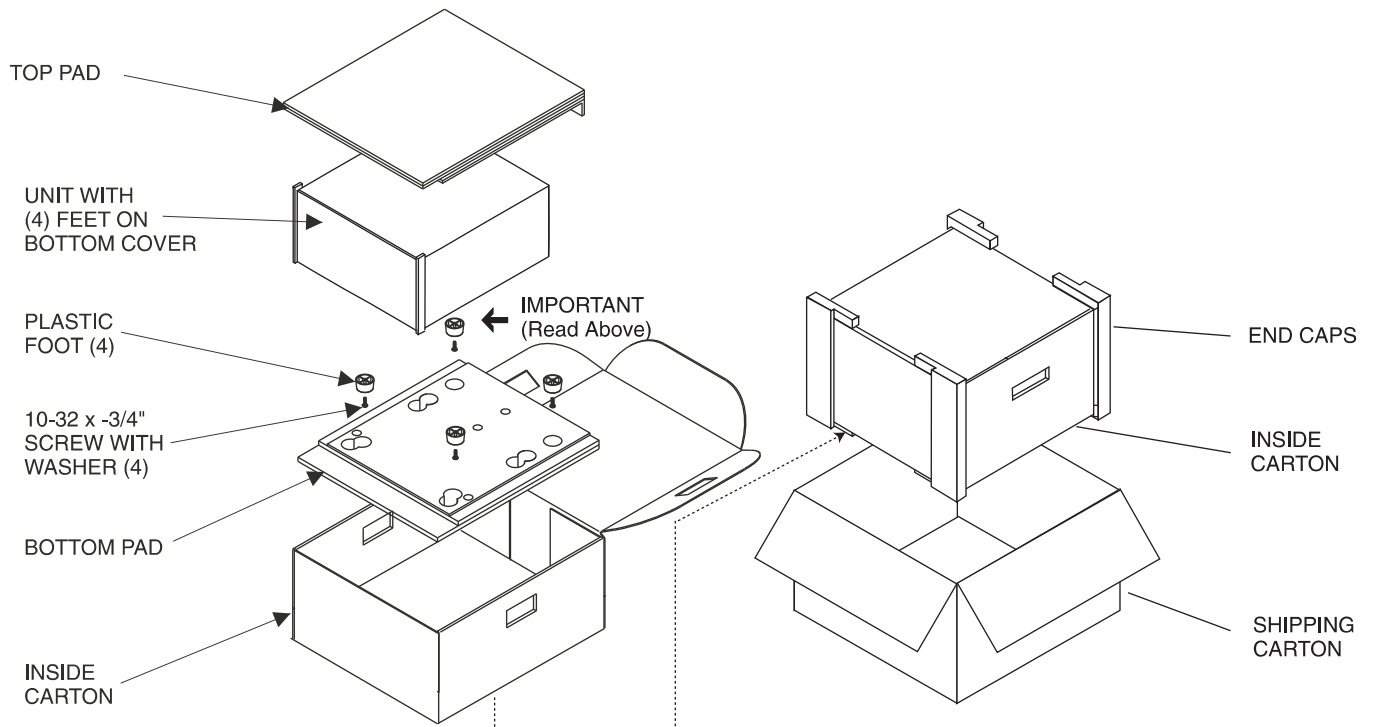

MS750

MUSIC SERVER

SERIAL NO. XU1001 And Above



The continuous improvement of its products is the policy of McIntosh Laboratory Incorporated, who reserve the right to improve design without notice. Because of the constant upgrading of McIntosh products' circuitry and components, the Company cannot insure, and does not warrant, the accuracy of the within schematic material, which is intended for information only.

McINTOSH LABORATORY, INC., 2 CHAMBERS STREET, BINGHAMTON, NEW YORK 13903 Printed in U.S.A. Part Number 041106